

AKAI

User Manual

PRIVATE MOBILE RADIO SET

APMP200



User Manual	(EN) 1-5
--------------------	----------

Gebruiksaanwijzing	(NL) 1-5
---------------------------	----------

Mode d'emploi	(FR) 1-5
----------------------	----------

Manual de Instrucciones	(ES) 1-5
--------------------------------	----------

SAFETY AND GENERAL INFORMATION

● **Important Information for Safe and Efficient Operation**

Please read this information before using your radio.

● **Safety and General**

1. Do not transmit more than 50% of time. It is important as the radio generates measurable RF energy exposure only when transmitting.
2. Do not open the radio. Any unauthorized modification may invalidate the guarantee.
3. Radio frequency signals transmitted may cause interference to hearing aids.
4. Turn off the radio when near medical equipment.
5. This product should not be used by people with pacemakers.
6. Do not use the radio when driving a vehicle or operating machinery.
7. Do not use the radio when on board aircraft.
8. Do not hold the antenna when transmitting.
9. Do not use the radio when the antenna has damaged.
10. Turn off the radio and remove the batteries if you are not going to use it for a long time.
11. Do not attempt to charge alkaline batteries.
12. Dispose of batteries according to local regulations. Do not dispose as household waste.

BATTERY LIFE

The approximate (typical) battery life for AA alkaline batteries is 30 hours.
This is based on 5% transmit, 5% receive and 90% standby cycle.

Corrosion, oxidation, battery-leakage and any other gradually acidic defect of this nature will invalidate the guarantee.

SPECIFICATIONS

Channel:	8
CTCSS-Code:	38
Operating frequency:	446.00625-446.09375 MHz
Coverage:	7 km (under optimal condition)
Power supply:	3xAA
Transmitter Power (Watts):	0.5ERP
Channel Spacing (kHz):	12.5
Power consumption:	≤ 500 mA
Standby power consumption:	≤ 45 mA

PMR446 frequency list		
Channel	Frequency	Description
1	446.00625 MHz	PMR
2	446.01875 MHz	PMR
3	446.03125 MHz	PMR
4	446.04375 MHz	PMR
5	446.05625 MHz	PMR
6	446.06875 MHz	PMR
7	446.08125 MHz	PMR
8	446.09375 MHz	PMR

OPERATIONAL CAUTIONS

1. Never dispose of batteries in a fire. There is a serious risk of explosion and /or the release of highly toxic chemicals.
2. Do not expose your product to direct sunlight, extreme cold or place it near heating appliances.
3. Do not submerge any part of your product in water and do not use it in damp, humid or wet conditions.
4. Do not expose your product to fire, explosive or other hazardous conditions. For example, at petrol stations or areas where explosive products are used.

YOUR NEW RADIO

The two-way radio operates on PMR446 frequencies, and can be used in Europe where the frequencies are authorized, subject to applicable regulations.

1. Antenna



- Power on/off.
- Increase/Decrease volume.

3. PTT

- Push to transmit, release to listen.
- Pressing **PTT** has 60 seconds limit.
- In menu mode, push to confirm selection.

4. mon/

- Push to monitor/scan channels.



- Push to decreases the channel / CTCSS Code / select VOX level and call tone.



- Short press to send a single call tone.
- Long press to send the call tone maximum 10 times, and then returns to standby mode automatically.

7. LCD

8. MODE/

- Short press to enter menu mode
 - Press one time to enter MENU mode, press or to select RF channel.
 - Press two times to enter CTCSS mode, press or to set CTCSS code.
 - Press three times to enter Call Tone mode, press or to set a new call tone.
 - Press four times to enter Sensitivity Level mode, press or to set sensitivity level.
 - Press five times to exit MENU mode.
- Long press to lock/unlock keypad.

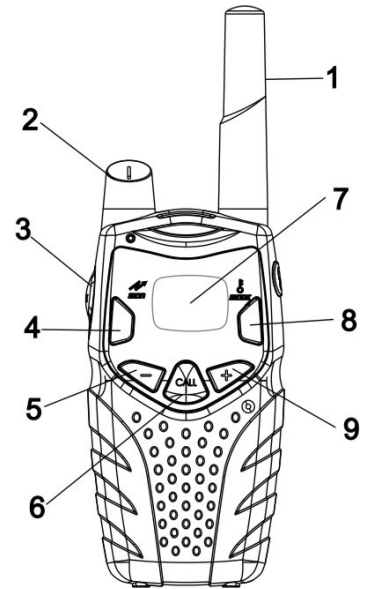

It will be automatically exited the menu mode if you have not pressed any key for several seconds when you in any mode.



- Push to increases the channel / CTCSS Code / select VOX level and call tone.



: displays the battery level



: displays the channel number



: displays the CTCSS Code



: Scanning



: Display when VOX function turns on



: Keypad locked



: talk confirmation tone

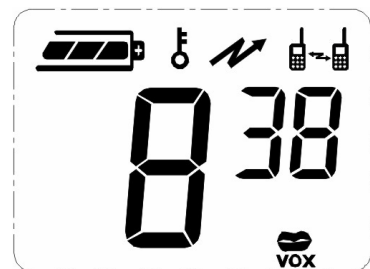

TURNING YOUR RADIO ON AND OFF

Turn clockwise to turn your radio on. The radio chirps and the display will show all feature icons that your radio has available for a brief period. The display will show the channel 1 - 8 and interference eliminator code 0 - 38.

Turn counterclockwise to turn your radio off.

TALKING AND LISTENING

Please read this manual carefully before using your new radio to ensure that you operate it both correctly and safely. Your radio has 8 channels. If you are in a group and you wish to talk to each other, all radios must be set to the same channel and interference eliminator code (CTCSS). If you experience interference and need to change channel, ensure that you change the channel and code of all radios in your group.

- For maximum clarity, hold radio 5 to 7 centimeters from mouth.



- Press and hold **PTT** key and speak into the microphone. LED indicator light glows continuously when transmitting.
- To receive messages, release **PTT** key.

Volume

Rotate  while holding down **mon/** key until you reach a comfortable listening level.



Rotate  clockwise to increase the volume or counterclockwise to decrease the volume.

Channel

1. Press **MODE/** button the channel number will begin to flash.
2. Use  or  button to change channel.
3. Press **PTT** button to set the new channel.

Select CTCSS Code

CTCSS help minimize interference by providing you with a choice of code combinations. The two radios must be of same channel and CTCSS code in order to communicate.

1. Press **MODE/** twice, the code number will begin to flash.
2. Press  or  to change the code.
3. Press **PTT** to set new code.

You can specify a different code for each channel.

Note: You must set the CTCSS to 0 on a radio that uses CTCSS to communicate with other radios that do not have CTCSS.

Time-out Timer

The time-out timer feature helps extend battery life by preventing accidental transmission. The radio will emit a continuous warning tone after **PTT** is pressed for 60 continuous seconds and will stop transmitting.

Keypad Lock

To avoid accidentally changing your radio settings, press and hold **MODE/** for 3 seconds until key lock icon is displayed. You can turn the radio on and off, adjust the volume, receive, transmit, send a call tone and monitor channels. All other functions are locked.

To unlock the radio, press and hold **MODE/** for 3 seconds and until key lock icon is no longer displayed.



Channel Busy Indicator

When a channel is busy, the LED flashes twice per second.

Setting and Transmitting Call Tone

Your radio can transmit different call tones to other radios in your group so you can alert them that you want to talk.

To set a call tone:

1. With the radio on, press **MODE/** 3 times. The current call tone setting flashes and CA is displayed.
2. Press  or  to change and hear the call tone.
3. Press **MODE/** or **PTT** to set the new call tone.



To transmit your call tone to other radios set to the same channel and Interference Eliminator Code as your radio, press

 button.

Note: This radio has 10 call tones. Setting the call tone to 0 disables the call tone feature.

Transmitting a Talk Confirmation Tone

When you turn on this feature, your two-way radio transmits a unique tone when you finish transmitting. It's like saying 'Roger' or 'Over', and lets others know you've finished talking. And at the same time, the icon  will display.

1. To turn talk confirmation tone on, press and hold  button while you turn the radio on. When you release **PTT** button after transmitting, your talk confirmation tone transmits.
2. To turn talk confirmation tone off, turn your radio off and then back on while pressing and holding  button.

Scan

Use scanning to monitor channels and codes for transmissions or to find someone in your group who has accidentally changed channels.



To start scanning, briefly press **mon/** key. The scan indicator  is shown.

When the radio detects channel activity, it stops scanning and you can hear the transmission. To respond to the transmission, press **PTT**.

To exit the function, press **mon/**  key again.

Note: If your radio's Interference Eliminator Code is set to 0 while scanning, the radio checks for activity on each channel regardless of the code used on the channel. If your radio's Interference Eliminator Code is set to 1-38 and ignores channels using code 0.

Scan Advance



If scan stops on a channel that you don't want to listen, briefly press  or  button to resume scanning for the next active channel.

Monitor

There are multiple channels shared among all users on the "take turn" basis. For uninterrupted communication, do not talk on a channel if someone else is currently talking on it. To check for activity on a channel before you talk, press and hold **mon/**  key. If you hear static, the channel is clear to use.

To exit the function, release **mon/**  key.

Removing Channels from the Scan List

To remove a undesired channel so the radio does not stop on it while scanning, press and hold  or  for at least 3 seconds, then release. This temporarily removes the channel from the scan list. You may remove more than one channel in this way.

To restore the channel, turn the radio off and then back on.

Note: You cannot remove the channel which your radio was set to (called your home channel) when you start scanning.

Hands Free Use (VOX)

VOX allows you to transmit hands free by talking while using optional headset accessories connected to the radio.



Note: Many accessories (sold separately) are available for your radio.

1. Turn the radio off.
2. Insert the plug of the VOX accessory firmly into the accessory jack.
3. Turn the radio on and  **VOX** is displayed.
4. Lower the radio volume before placing the accessory on your head or in your ear.
5. To transmit, speak into the accessory microphone. There is a short delay between the time you start talking and radio transmission.
6. To receive, stop talking.

To turn  **VOX** off, press **PTT** or remove the VOX accessory.

Baby Monitor Feature





Your radios may be used as a baby monitor. To use this feature:

1. Turn off your radio.
2. Turn your radio on with **PTT** button pressed.
The " **VOX**" icon will appear in the display to indicate that the baby monitor feature is active.
To transmit, speak into the radio microphone. To receive, simply stop talking.
3. Pressing **PTT** to transmit will disable the baby monitor feature.
4. Press **PTT** button again to activate the baby monitor again. " **VOX**" will appear on the screen again.

Note: When using the baby monitor feature, there is a short delay after you start talking, before the radio transmits.

Setting Sensitivity Levels

Adjusting your radio's sensitivity level helps minimize the possibility of unintended noise triggering a transmission and helps the radio pick up soft voices.

1. Press **MODE** /  4 times or until the sensitivity level number and " **VOX**" is shown.
2. Press  or  to select the sensitivity level:
 - 1 = Low Sensitivity (for noisy environments)
 - 2 = Medium Sensitivity (for most environments)
 - 3 = High Sensitivity (for quiet environments)

Note: When you connect a VOX accessory, the radio is automatically set to the last chosen sensitivity level.

Battery Meter

The battery icon shows the battery charge level from full  to  empty. When the battery is empty, the radio

chirps periodically after you release the **PTT** key. The radio powers off when the voltage drops below a predetermined level to protect the rechargeable battery.

Note: Remove the batteries before storing your radio for extended periods of time. Batteries corrode over time and may cause permanent damage to your radio.

Disposal of Used Electrical & Electronic Equipment

The meaning of the symbol on the product, its accessory or packaging indicates that this product shall not be treated as household waste. Please, dispose of this equipment at your applicable collection point for the recycling of electrical & electronic equipments waste. In the European Union and Other European countries which there are separate collection systems for used electrical and electronic product. By ensuring the correct disposal of this product, you will help prevent potentially hazardous to the environment and to human health, which could otherwise be caused by unsuitable waste handling of this product. The recycling of materials will help conserve natural resources. Please do not therefore dispose of your old electrical and electronic equipment with your household waste. For more detailed information about recycling of this product, please contact your local city office, your household waste disposal service or the shop where you purchased the product.



<http://www.akai.eu>