

AKAI

MANUAL DE UTILIZARE

TELEVIZOR LED(FULL HD) 24 “ CU PLAYER DVD

ALED2402



1.SIGURANTA

1.1 Inainte de folosire

Acest LCD TV/DVD COMBI reda filme si fotografiile de pe DVD.Aparatul reda muzica de pe CD.Aparatul are toate caracteristicile unui TV pentru receptia canalelor analogice.Poate fi folosit de asemenea ca monitor pentru calculator.

Cititi manualul cu atentie.

1.2 Etichetele manualului.

ATENTIE!



Acest simbol avertizeaza in privinta existentei unor tensiuni periculoase in interiorul aparatului care sunt suficient de puternice pentru a provoca electrocutarea.



Acest semn indica utilizatorului existenta unor operatiuni si instructiuni deosebite legate de intretinere.

1.3 Instructiuni generale de siguranta

- Nu impingeti aparatul. Poate sa cada si sa cauzeze raniri.
- Nu lasati sa curga nici un lichid in interiorul aparatului.
- Nu lasati sa patrunda obiecte metalice prin fantele de aerisire.
- Nu blocati fantele de aerisire.

Nota:

- Acest aparat are dubla izolatie :de aceea nu este necesara impamantarea. Verificati numai daca tensiunea de alimentare locala corespunde cu cea de pe eticheta aparatului.

2. Pregatirea pentru folosire

2.1 Despachetarea

*Despachetati aparatul cu grija

*Verificati continutul conform celor de mai jos. Daca lipseste ceva contactati magazinul.

* Indepartati etichetele de pe panoul fata cu grija.

Se recomanda sa pastrati ambalajul original si materialele de ambalaj in caz ca sunt necesare ulterior. Este singurul mod de a proteja aparatul la transport. Daca aruncati totusi ambalajul aveti grija sa-l reciclati.

2.2 Continutul ambalajului

Urmatoarele componente sunt incluse in ambalajul primit:

1. TV LED/DVD COMBI
1. Picior
1. Cablu de retea
1. Telecomanda
2. Baterii (AA)
1. Manual de utilizare.

Daca ceva din lista de sus este lipsa contactati magazinul.

3. Instalare

- Asezati aparatul in configuratia dorita
- Daca aparatul trebuie instalat pe picior ,cititi paragraful “Montarea piciorului”.
- Conectati echipamentele externe .Cititi paragraful “Conectarea echipamentelor externe”
- Conectati aparatul la retea .Cititi paragraful “Conectarea la retea”
- Instalati bateriile in telecomanda. Cititi paragraful “Telecomanda”

ATENTIE!

*Nu asezati aparatul langa surse de caldura,

*Nu expuneti aparatul direct in lumina soarelui.

Nota:

- Acest aparat este echipat cu picioare dintr-un material special pentru a evita miscarea acestuia. Totusi este posibil ca pe o anumita suprafata de mobila mai lucioasa acestea sa alunece. Se recomanda in acest caz montarea unei bande adezive pe picioarele aparatului inainte de al monta pe mobila.

3.1 Montarea piciorului

- Asezati aparatul pe o suprafata neteda orizontala cu ecranul in jos.
- Introduceti aparatul (A) in standul (B).
- Rotiti standul (B) in directia sagetii pana se aude un click
- Asezati aparatul in picioare. Asezati-l pe o suprafata neteda orizontala.

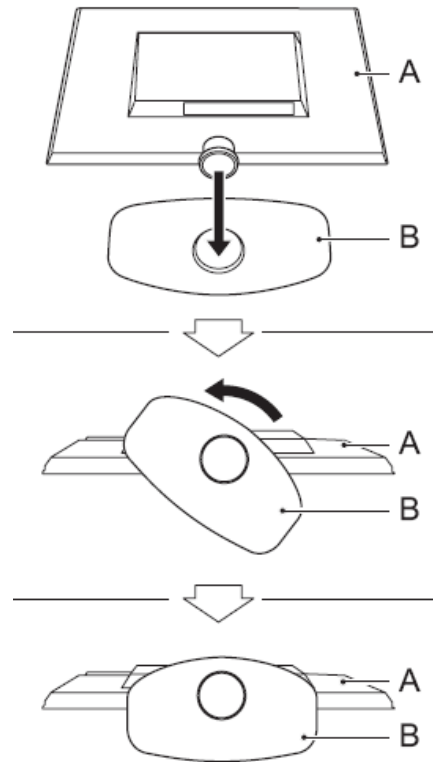

3.2 Conectarea echipamentelor externe.

Aparatul include diferite optiuni de conectare a echipamentelor. Cablurile corespunzatoare pot fi procurate din magazinele de specialitate.

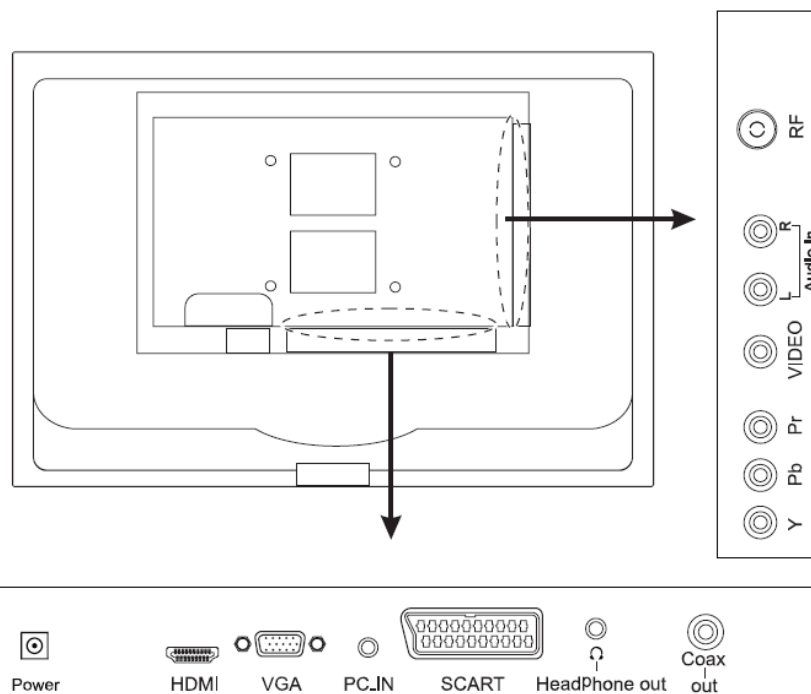

Conectarea Audio (intrare)

Aceasta conectare va permite receptia unui semnal audio stereo de la VCR sau amplificator.

- L/R Audio. Conectati un cablu corespunzator la canalele R/L ale mufelor AUDIO.

Conectarea Video

Aparatul are urmatoarele iesiri video (in ordinea preferintelor)

- COMPONENT: Conectati un cablu corespunzator Pr/Y/Pb la mufele COMPONENT.
- SCART: Introduceti un cablu corespunzator la mufa SCART OUT.
- HDMI: Introduceti un cablu corespunzator la mufa HDMI.
- COMPOSITE: Introduceti un cablu corespunzator la mufa VIDEO .

Conectarile PC

Aparatul are urmatoarele intrari pentru conectarea unui calculator personal

- Conectarea Audio: Conectati un cablu corespunzator la PC-AUDIO
- Conectarea Video: Conectati un cablu corespunzator la mufa VGA.

Conectarea cablului.

- Introduceti un cablu corespunzator la mufa RF TUNER .

Conectarea castilor

- Conectati castile introducand cablul la mufa casti. Pentru a evita afectarea auzului nu uitati sa reglati volumul al minim.
- Conectati steckerul la priza.

Conectarea cablului de antena

- Introduceti un cablu corespunzator la mufa RF OUT

3.4 Telecomanda

Instalarea bateriilor

- Deschideti usa compartimentului bateriilor
- Introduceti bateriile urmarind respectarea polaritati (+) si (-) marcate.
- Asezati la loc usa compartimentului.

ATENTIE!

Instalarea incorecta a bateriilor poate conduce la curgerea acestora si corodarea si defectarea aparatului. Corodarea ,oxidarea ,curgerea bateriilor sau orice defectare gradata de aceasta natura anuleaza garantia.

4. FUNCTII

4.1 LED TV/DVD Combi

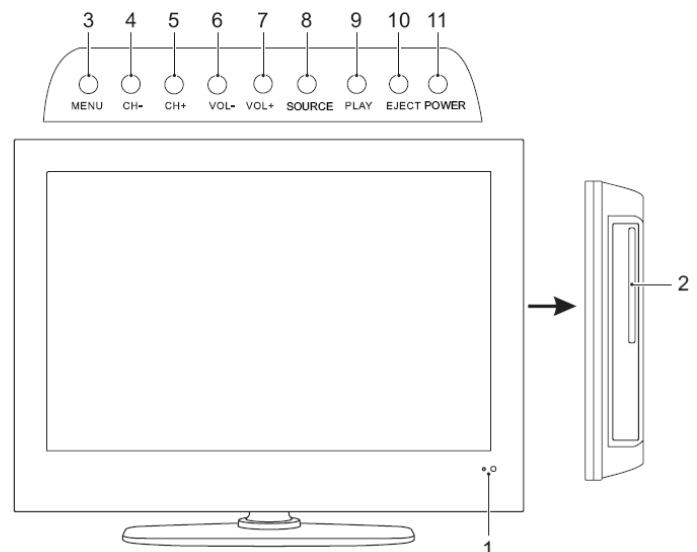

1. Senzor Telecomanda
Lampa indicatoare STANDBY
2. Usita DVD

Panoul Fata

3. Butonul MENU
4. Butonul CH -
5. Butonul CH +
6. Butonul VOL-
7. Butonul VOL+
8. Butonul SOURCE
9. Butonul PLAY
10. Butonul EJECT
11. Butonul POWER

4.2 Telecomanda

Funcții generale

12. Butonul POWER
13. Butoanele Digitale (0-10+)
14. Butonul VOL+
15. Butonul VOL -
16. Butonul CH +
17. Butonul CH -
18. Butonul SYS MENU
19. Butonul SOUND
20. Butonul PICTURE
21. Butonul ASPECT
22. Butonul NICAM/A2
23. Butonul TIMER
24. Butonul DISPLAY
25. Butonul sageti
26. Butonul ENTER
27. Butonul RETURN
28. Butonul MUTE
29. Butonul SOURCE

Funcțiile TELETEXT

30. Butonul CANCEL
31. Butonul TV/TXT
32. Butonul SIZE
33. Butonul HOLD
34. Butoanele colorate
35. Butonul INDEX
36. Butonul SUBPAGE
37. Butonul REVEAL

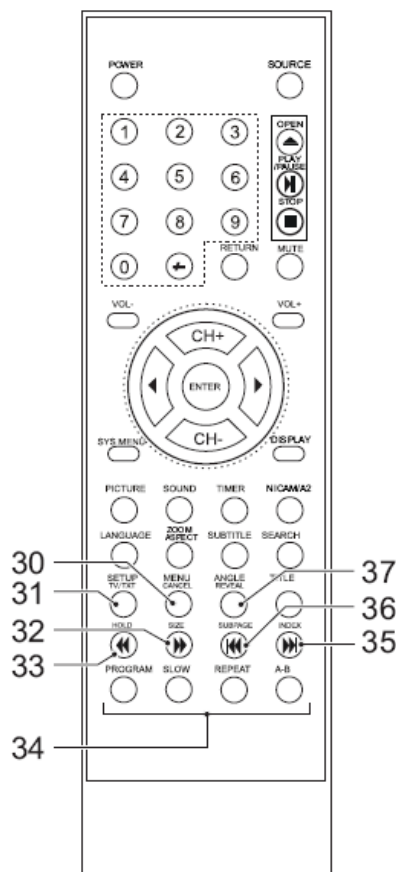
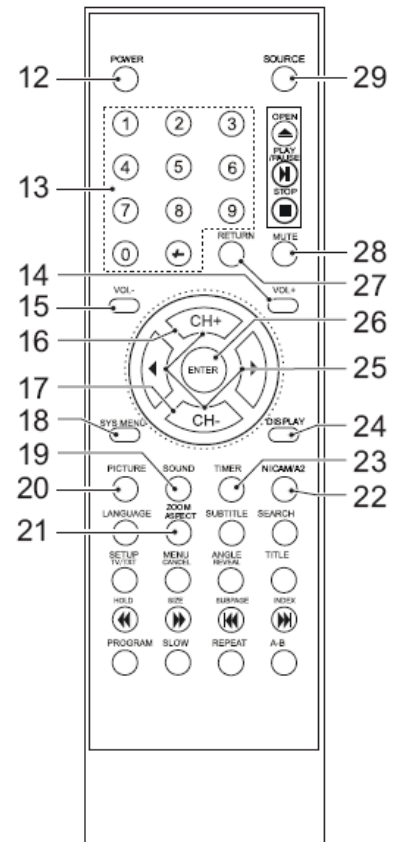

Funcțiile DVD

- 38. Butonul ZOOM
- 39. Butonul LANGUAGE
- 40. Butonul MENU
- 41. Butonul SETUP
- 42. Butonul FWD
- 43. Butonul REW
- 44. Butonul SLOW
- 45. Butonul PROGRAM
- 46. Butonul A-B
- 47. Butonul REPEAT
- 48. Butonul NEXT
- 49. Butonul PREV
- 50. Butonul TITLE
- 51. Butonul ANGLE
- 52. Butonul SEARCH
- 53. Butonul SUBTITLE
- 54. Butonul DISPLAY
- 55. Butonul STOP
- 56. Butonul PLAY/PAUSE
- 57. Butonul OPEN

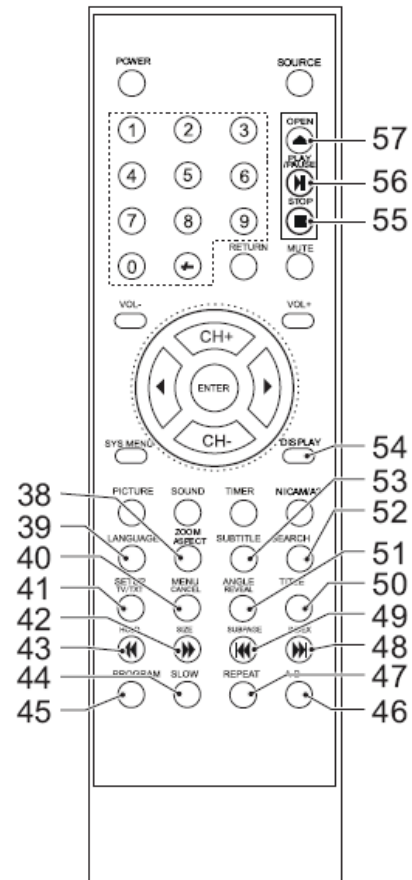

FUNCTIONAREA

Toate funcțiile aparatului sunt accesibile de pe telecomanda
Toate instrucțiunile sunt cu referire la folosirea cu telecomanda
daca nu este altfel indicat.

5.1 Pornirea rapida

Funcții Generale

- Pentru a porni aparatul apasati butonul POWER (12) .Pentru oprirea aparatului apasati din nou butonul POWER(12)
- Pentru selectarea modul sursa (TV/AV/Y-Pb-Pr/DVD/SCART/VGA/HDMI) apasati butonul SOURCE(29)
- Pentru a regla volumul ,apasati butoanele VOL+ (14)sau VOL- (15)
- Pentru oprirea temporara a sunetului apasati butonul MUTE (28) .Apasandu-l inca o data se revine la sunet normal.
- Pentru a programa timerul sleep (OFF/15/30/45/60/90/120min) apasati butonul TIMER 923)
- Pentru a alege modul imagine dorit (USER/NORMAL/SOFT/VIVID) apasati butonul PICTURE(20)
- Pentru a selecta dimensiunea ecranului (AUTO/16: 9/ZOOM 1/ZOOM 2) apasati butonul ASPECT (21)
- Pentru a alege modul sunet (USER/NORMAL/NEWS/MOVIE) apasati butonul SOUND(19)
- Pentru a afisa programările pe ecran apasati butonul DISPLAY(24)

Funcțiile DVD/CD

- Porniti aparatul
- Selectati modul DVD

- Introduceți un disc în locul (2) ,cu eticheta în sus.
- Pentru a porni redarea apăsați butonul PLAY/PAUSE(56) o dată.

5.2 Folosirea menu Programare TV

Următoarele acțiuni pot fi activate prin telecomandă

- Apăsați butonul SYS MENU(18)
- Apăsați butoanele săgeți sus/jos (25) pentru a alege un menu
- Apăsați butoanele săgeți dreapta (25) pentru a intra în menu selectat.
- Apăsați butoanele săgeți sus/jos(25) pentru a regla parametrul dorit
- Apăsați butonul SYS MENU (18) pentru memorarea programărilor și ieșirea din menu.

Menu Imagine

- PICTURE MODE: pentru a selecta modurile imagine
USER/NORMAL/SOFT/VIVID
- BRIGHTNESS: reglează strălucirea ecranului.
- CONTRAST: reglează contrastul ecranului
- SATURATION: reglează culoarea ecranului.
- SHARPNESS: reglează granulația ecranului.
- HUE: reglează nuanța culorii. Această opțiune este activă numai în cazul redării NTSC.
- SCALE: pentru a selecta mărimea ecranului (AUTO/16:9/4:3/ZOOM 1/ZOOM 2)

Menu Sunet

- MOD SUNET : pentru a programa modul sunet
(USER/NORMAL/NEWS/MOVIE)
- VOLUME: pentru reglajul volumului
- BASS: pentru a regla frecvențele JOASE
- TREBLE: pentru a regla frecvențele ÎNALTE
- BALANCE: pentru a regla BALANSA

Menu Canal (numai în modul TV)

- AUTO TUNE : pentru căutarea automată a canalelor
- MANUAL TUNE : pentru a căuta canalele manual
- FINE TUNE; pentru căutare fină a canalelor cu imagine de slabă calitate.
- SKIP: pentru a sări canalele cu imagine slabă.
- SOUND SYS: pentru a selecta sistemul de sunet
- PROGRAM EDIT : pentru a edita programul.

Funcția MENU

- LANGUAGE: pentru a alege limba pentru OSD (afisaj pe ecran)
- BLUE BACK: pentru a porni(ON) sau opri (OFF) culoarea protecție ecran.
- TTX LANGUAGE: pentru a selecta ariile de limbă a teletextului
(WEST/EAST/RUSSIAN/ARABIC/FARS)
- COLOR TEMP: temperatura culorii imaginii (COOL/WARM/NORMAL)
- HOTEL LOOK: pentru a opri (OFF) sau porni(ON) accesul la programările TV
(parola :0000). Aveți grijă de această parolă pentru a permite revenirea la programările inițiale.
- HOTEL MODE: pentru a porni/opri modul hotel.
- VOLUME CONTROL: pentru a porni/opri controlul volumului.

- TUNNER CONTROL: pentru a porni/opri controlul tunerului.
- MAX VOLUME: pentru a fixa volumul la maxim.
- CHANGE PASSWORD: pentru a schimba parola la modul hotel.
- SOURCE LOCK :pentru a alege sursa dintre cele prohibitive sau oricare intrare externa
- KEYPAD LOCK: pentru a bloca/debloca butoanele TV
- PROG SET : pentru a programa sursa (OFF/TV/AV/Y-Pb-Pr/SCART/GA/HDMI)
- PROG NUM: pentru a selecta numarul programului.
- RESEST: pentru a reveni la programarile initiale.

Menu PC(numai in modul PC)

- H-POSITION;pentru a regla pozitia orizontala pe ecran
- V-POSITION : pentru a regla pozitia verticala pe ecran
- CLOCK: pentru a regla frecventa pixelilor ceasului pana ce dimensiunea este maxima pentru ecran.
- PHASE: pentru a regla faza ceasului de sampling ADC fata de semnalul de sincronizare astfel incat sa se obtina o imagine stabila.
- AUTO ADJUST:pentru reglajul automat al parametrilor ecranului.

5.3 Functiile Teletext

- Apasati butonul TV/TXT (31) pentru a deschide modul teletext
- Pentru a alege o pagina apasati numarul folosind butoanele numerice .
- Pentru a selecta pagina urmatoare sau anterioara, apasati butonul CH + (16) sau butonul CH- (17)
- Pentru a reveni la pagina index ,apasati butonul INDEX(35).
- Pentru afisarea informatiilor ascunse ,apasati butonul REVEAL(37) .Optional pentru unele pagini teletext.
- Pentru a comuta subtitlurile ,apasati butonul MIX (30) .Apasati butonul inca o data pentru a iesi din aceasta functie.
- Pentru a selecta marimea paginii Teletext:
 - Apasati butonul SIZE(32) o data, pentru a mari jumatatea de sus a paginii.
 - Apasati acelasi buton inca o data pentru a mari partea de jos a paginii.
 - Apasati butonul din nou pentru a reveni la teletext normal.
- Pentru a tine o pagina Teletext ,apasati butonul HOLD(33)
- Apasati butoanele colorate pentru selectarea rapida a paginilor teletext (34)

5.4 FUNCTIILE DVD/CD

Dupa introducerea unui disc menu continut apare pe afisajul TV.

- Apasati butoanele sageti (25) pentru a alege un parametru
- Apasati butonul ENTER (26) pentru a intra in parametrul menu selectat.

In timpul redarii urmatoarele functii sunt active:

- Pentru a selecta un capitol(DVD) sau o melodie (CD) apasati butoanele digitale (13)
- Pentru a selecta capitolul sau melodia urmatoare sau anetrioara apasati butonul NEXT (48) sau PREV(49).
- Pentru cautare rapida inainte sau inapoi pe DVD apasati butonul FWD(42) sau REW (43) .Sunt posibile vitezele: 2x ,4x , 8x,20x..
- Pentru pauza pe redare ,apasati butonul PLAY/PAUSE (56) o data. Pentru preluarea redarii apasati acelasi buton inca o data.

- Pentru stop temporar pe redare apasati butonul STOP(55) o data.Pentru stop permanent apasati-l inca o data sau apasati butonul PLAY/PAUSE (56).
- Pentru redarea cu viteza mica ,inainte sau inapoi apasati butonul SLOW (44) repetat.Vitezele posibile sunt :1/2,1/3,1/4,1/5,1/6,1/7.
- Pentru a repeta un capitol (DVD) sau una sau toate melodiile CD :
 - Apasati butonul REPEAT (47) o data pentru a repeta capitolul sau melodia in redare.
 - Apasati butonul inca o data pentru repetarea titlului curent.
 - Apasati butonul inca o data pentru a repeta toate capitolele sau melodiile.
 - Apasati butonul inca o data oentru a anula functia.
- Pentru a vizualiza un titlu specific pe DVD ,apasati butonul TITLE(50) .Folositi butoanele sageti pentru a selecta titlul.
- Pentru a selecta limba audio a unui DVD ,apasati butonul LANGUAGE (39) repetat pana ajuneti la limba dorita.
- Pentru a comuta subtitlurile la un DVD apasati butonul SUBTITLE (53).Apasati butonul din nou pentru a opri subtilul.
- Pentru a selecta extra informatii despre DVD sau CD (timpul ramas/trecut/numarul melodiei/numarul capitolului) apasati butonul DISPLAY (54)
- Pentru a selecta unghiul camerei apasati butonul ANGLE (51)
- Pentru a reveni la menu principa apasati butonul MENU(40)
- Un DVD care nu are codul regional corect ,2 in cazul Romaiei, nu poate fi redat cu acest aparat.

Folosirea functiei PROGRAM

- Apasati butonul ROGRAM (45) pentru a intra in functia PROGRAM
- Pentru a reda melodiile de pe un CD:
 - Apasati butoanele sageti (dreapta) (25) pentru a sublinia un tiltu
 - Apasati butoanele sageti (sus-jos) (25) pentru selectarea unui titlu
- Pentru a reda capitolele unui DVD:
 - Apasati butoanele sageti (dreapta) (25) pentru a sublinia un titlu.
 - Apasati butoanele sageti (sus-jos) (25) pentru a selecta un titlu.
 - Apasati butaonele sageti (dreapta) (25) pentru a sublinia un capitol.
 - Apasati butoanele sageti (dreapta) (25) pentru a selecta un capitol.
- Pentru a onfirma selectai apasati butonul ENTER(26)
- Repetati ultimii doi pasi pentru titluri su capitole suplimentare.
- Apasati butonul PLAY/PAUSE (56) pentru a porni programul.

Folosirea functiei A-B REPEAT.

Functia A-B REPEAT poate fi folosita pentru a repeta un fragment specificat a unui DVD.

- Apasati butonul A-B (46) o data pentru a marca punctul de pornire A
- Apasati butonul A-B (46) din nou pentru a marca punctul de sfarsit B. Aparatul va reda repetat sectiunea A-B.
- Apasati butonul A-B (46) pentru a anula functia.Aparatul va relua redarea normala.

Folosirea functiei SEARCH

Functia SEARCH poate fi folosita pentru a alege un punct specific de pornire a DVD sau CD.

- Apasati butonul SEARCH (52) (25)

- Apasati butoanele sageti pentru a selecta inceputul.

Posibilele intrari pentru DVD sunt:

- Timpul discului
- Capitolul
- Titlul
- Timpul Capitolului
- Timpul Titlului.

Posibilele intrari pentru CD sunt:

- Timpul Melodiei
- Melodia Specifica
- Apasati butoanele numerice pentru a alege o selectie.

Folosirea functiei redare MP3/MPEG4

- Introduceti un disc MP3/MPEG4. Menu continut va fi afisat pe ecranul TV.
- Apasati butoanele sageti sus/jos (15/17) pentru a selecta un folder sau fisier.
- Apasati butonul ENTER(26) pentru a intra in folderul sau fisierul selectat.
- Apasati butonul MENU(40) pentru a comuta intre foldere si fisiere. Apasati butonul ENETR (26) pentru confirmare.

5.5 Folosirea Menu Programare DVD

Acest menu este accesibil numai in modul DVD

Pentru a schimba programarile initiale.

Urmatoarele operatiuni pot fi actionate din telecomanda.

- Apasati butonul SETUP (41) pentru a selecta menu programare.
- Apasati butoanele sageti pentru a selecta un parametru si a schimba programarile.
- Apasati butonul SETUP (41) pentru a memora programarile si a iesi din menu.

Pagina Programare System

Acest menu este activ numai daca nu este disc in aparat.

TV SYSTEM

- Pentru a selecta sistemul de culoare NTSC/PAL/AUTO

TIP TV

- Pentru a selecta sistemul de culoare 4:3PS/4:3LB/16:9

PASSWORD(parola)

- Pentru a selecta parola

RATING

- Pentru a selecta parola pentru nivel acces copii.

DEFAULT (initial)

- Pentru a reveni la programarile initiale.

Pagina Programare Limba

- In sectiunea OSD LANGUAGE apasati butoanele sageti pentru a alege limba.
- In sectiunea AUDIO alegeti limba audio .
- In sectiunea SUBTITLE alegeti limba subtitlu.
- In sectiunea DVD MENU alegeti limba pentru menu DVD.

Pagina Programare Audio

IESIRI AUDIO

- Alegeti SPDIF OFF pentru a comuta iesirea audio pe semnal digital.
- Alegeti SPDIF RAW pentru a fixa iesirea audio digitala in format raw (DTS/Dolby Digital 5.1)
- Alegeti SPDIF PCM pentru a fixa iesirea audio digitala in format PCM.

Pagina Programare Digital

DYNAMIC

- Alegeti valoarea pentru domeniul dinamic de compensare pentru a evita pierderea detaliilor sunetului la volum mic.

DUAL MONO

- Stereo: ambele canale asa cum sunt .STEREO este programat initial din fabrica.
- L-Mono: numai canalul stanga
- R-Mono : numai canalul dreapta
- Mix-Mono: media intre canalul stanga si dreapta.

Aceasta functie este activa numai la discurile codate cu doua canale Dolby AC-3.

Intretinerea aparatului

Curatarea carcasei

Important : deconectati de la priza aparatul inainte de a-l curata. Folositi o carpa uscata. Daca carcasa este foarte murdara, imbibati carpa cu o solutie slaba de detergent neutru sau apa si curatati.

Curatarea lentilelor

O lentila murdara poate cauza distorsionarea sunetului si daca aceasta este foarte murdara, playerul CD nu va functiona. Deschideti usita CD si curatati cu grija lentila.

Curatarea particulelor de praf

Folositi o pensula pentru a curata lentila de praf si un betisor cu vata pentru a o curata de amprente digitale.

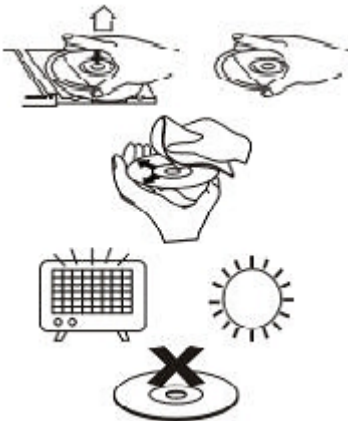
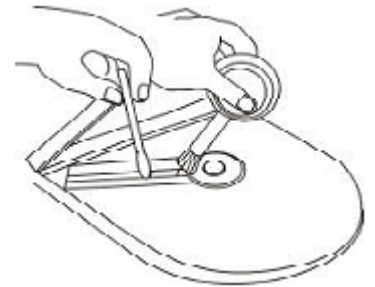

Curatarea discului

Cand curatati discul nu atingeti partea colorata in curcubeu.

Folositi o carpa uscata. Nu folositi benzina sau alta substanta care va deteriora discul. Acesta trebuie curatat in linie dreapta de la centru catre margini. Nu trebuie curatat intr-un mod circular.

Nu amplasati discul pe alte echipamente sau in apropierea unei surse de caldura. Evitati sa expuneti discul la razele solare pentru

7. IN CAZ DE PROBLEME

problema	actiunea
Sunet incomplet sau lipsa	Verificati echipamentul extern sa fie pornit si programat corect
	Verificati conectarea cablurilor
	Verificati daca a fost selectata corect sursa
	Verificati nivelul volumului si daca nu a fost actionat mutingul
Lipsa Imagine	Verificati daca TV este pornit si intrarile A/V sunt conectate corect
	Verificati conectarea cablurilor

Nu se alimenteaza	Verificati daac cablul de retea este conectata correct la priza
	Verificati intrerupatorul general de pe spatele aparatului
Functionare defectuoasa	Daca aparatul functioneaza defectuos ,decuplati-l de l aretea timp de 30 minute.Daca totusi problema persista apelati la service.

DVD/CD

Nu reda	Nu aveti disc in aparat.Incarcati un disc cu eticheta in sus
	Discul este incarcat gresit.
	Nivelul de acces al discului este mai mare decat cel programat,reprogramati aparatul.
	Codul regional este diferit
	Tip de disc incorect
	Condens in aparat. Scoate-ti discul si lasati aparatul in priza un timp pentru eliminarea condensului
Lipsa sunet au sunet incomplet	Alegeti alta melodie
	In timpul SCAN,SLOW MOTION sau SINGLE STEP sunetul este oprit.Verificati daca discul este in cautare repede inainte sau inapoi.Apasati butonul PLAY/PAUSE(28)
Nu este posibil scan sau skip	Unele discuri sunt programate sa refuze anumite comenzi ale utilizatorului la anumite sectiuni.Nu este defect.Discurile cu un singur capitol sau melodie nu permit functia skip
Imagine distorsionata sau cu zgomot	Discul poate fi murdar sau defect.Curatati-l sau incercati alt disc.Verificati sitemul TV (PAL/NTSC).Daca aveti un VCR conectat intermediar, eliminati-l si face-ti direct conectarile
	Curatati discul
Imaginea nu acopera tot ecranul	Alegeti formatul ecranului din menu programari .
	Alegeti formatul ecranului din menu start disc.

Telecomanda

Telecomanda nu functioneaza	Verificati daca aveti baterii
	Indreptati TL catre senzorul aparatului
	Apropiati-va la mai putin de 8 metri fata de aparat.

8.Date Tehnice

Parametrii	Value
Tensiune	100 ~240 Vac/50 ~ 60Hz
Putere consumata	60 W
Putere consumata in standby	< 1 W

Putere maxima de Iesire 2 x 3 W (2 x 1 W RMS)

Ecran LED

Parametru	valoare
Diagonala	60 cm(24")
Raport imagine	16:9
Rezolutie	1920 x 1080 pixeli
Starlucire	250 cd/m ²
Raport Contrast	1000 : 1
Timp de raspuns	5 ms
Unghi de vizualizare oriz/vert	170°/160°
Sistem Televiziune	PAL/SECAM

Generale

Telecomanda baterii 2 x 1,5 V tip AA

9. Reciclarea echipamentelor electrice si electronice uzate



Acest simbol prezent pe produs sau pe ambalaj semnifica faptul ca produsul respectiv nu trebuie tratat ca un deșeu menajer obișnuit .Nu aruncați aparatul la gunoierul menajer la sfârșitul duratei de funcționare ,ci duceți-l la un centru de colectare autorizat pentru reciclare .In acest fel veți ajuta la protejarea mediului inconjurator si veți putea impiedica eventualele consecințe negative pe care le-ar avea asupra mediului si sanatatii umane.

Pentru a afla adresa celui mai apropiat centru de colectare :

- Contactati autoritatile locale ;
- Accesati pagina de internet :www.mmediu.ro
- Solicitati informatii suplimentare de la magazinul de unde ati achizitionat produsul

AKAI

LED TV with built-in DVD player

ALED2402



User manual

GB 2

Gebruiksaanwijzing

NL 25

Manuel de l'utilisateur

FR 49

Manual de instrucciones

ES 73

Gebrauchsanleitung

DE 97

Οδηγίες χρήσεως

EL 122

Brugsanvisning

DA146

Table of contents

1.	Safety	3
1.1	Intended use	3
1.2	Labels in this manual	3
1.3	General safety instructions	3
2.	Preparations for use	4
2.1	Unpacking	4
2.2	Package contents	5
3.	Installation	5
3.1	Mounting the stand	6
3.2	Connecting random equipment	7
3.3	Connecting to the mains	8
3.4	Remote control	8
4.	Functions	9
4.1	LED TV/DVD Combi	9
4.2	Remote control	10
5.	Operation	13
5.1	Quick start	13
5.2	TV setup menu operation	14
5.3	TV functions	16
5.4	DVD/CD functions	16
5.5	DVD setup menu operation	19
6.	Cleaning and maintenance	20
6.1	Handle and care of a disc	20
7.	Troubleshooting	21
8.	Technical data	23
9.	Disposal of used electrical and electronic equipment	24

Copyright notice

Design and specifications are subject to change without notice.

1. Safety

1.1 Intended use

The LED TV/DVD Combi plays film and photos from DVD. The appliance also plays music from CD. The appliance can also be used as a TV and as a monitor for a personal computer. Read the manual carefully before first use.



DVDs and DVD appliances are manufactured under the worldwide agreed DVD regional code system that the appliance will operate only with corresponding disc of the same regional code. If the code number on the label of a DVD does not match that on the label alongside, the DVD will not play on this appliance.



The appliance has built-in copyright protection technology that prevents copying from a disc to any media. If a video recorder is connected to the appliance, the video output image will be distorted during recording.

1.2 Labels in this manual



WARNING

A warning means that injury or death is possible if the instructions are not obeyed.



CAUTION

A caution means that damage to the equipment is possible.



A note gives additional information, e.g. for a procedure.

1.3 General safety instructions



WARNING

Do not put force on the appliance. The appliance can fall and can cause serious injury.

**CAUTION**

Do not spill any liquid on the appliance.

**WARNING**

Do not insert any objects in the ventilation holes.

**CAUTION**

Do not block the ventilation holes.



This appliance is double insulated; therefore no earth wire is required. Always check that the mains voltage corresponds to the voltage on the rating plate. Never attempt to replace the adaptor plug with a regular mains plug.



This appliance employs a laser system. To prevent direct exposure to the laser beam, do not open the appliance. Visible laser radiation when open and interlock defeated.

2. Preparations for use

2.1 Unpacking

- Unpack the appliance carefully.
- Check the package contents as described below. If any item is missing, please contact your reseller.
- Remove the labels from the front panel carefully if present.



We recommend that you retain the original carton and packing materials in case it ever becomes necessary to return your product for service. This is the only way to safely protect the product against damage in transit. If you do dispose of the carton and the packing materials, please remember to recycle with due care to the environment.

2.2 Package contents

The following items are included in the received package:

- 1 LED TV/DVD Combi
- 1 Foot
- 1 Mains cable
- 1 Remote control
- 2 Batteries (AA)
- 1 Operator manual

3. Installation

- Place the appliance on the stand. Read the paragraph "Mounting the stand".
- Connect the random equipment to the appliance.
Read the paragraph "Connecting random equipment".
- Connect the appliance to the mains.
Read the paragraph "Connecting to the mains".
- Install the batteries in the remote control.
Read the paragraph "Remote control".



CAUTION

- Do not put the appliance near a heat source.
- Do not expose the appliance to direct sunlight.



This appliance is equipped with rubber feet to prevent it from moving. The feet are made from non-migrating material specially formulated to avoid leaving any marks or stains on furniture. However, certain types of furniture polishes, wood preservatives or cleaning sprays cause the rubber to soften and leave marks or a residue on the furniture, and potentially risk the surface to become damaged. To prevent damage to wooden surfaces, we recommend that you apply self-adhesive pads to the bottom of the rubber feet before installation.

3.1 Mounting the stand

- Put the appliance on a horizontal flat surface, with the screen upside down.
- Insert the appliance (A) into the stand (B).
- Turn the stand (B) into the direction of the arrow until the stand clicks into place.
- Put the appliance straight up. Put the appliance on a horizontal flat surface.

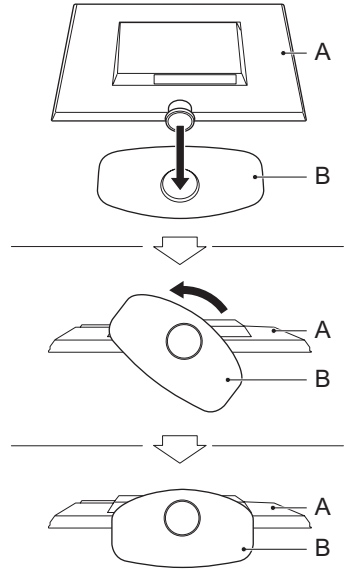

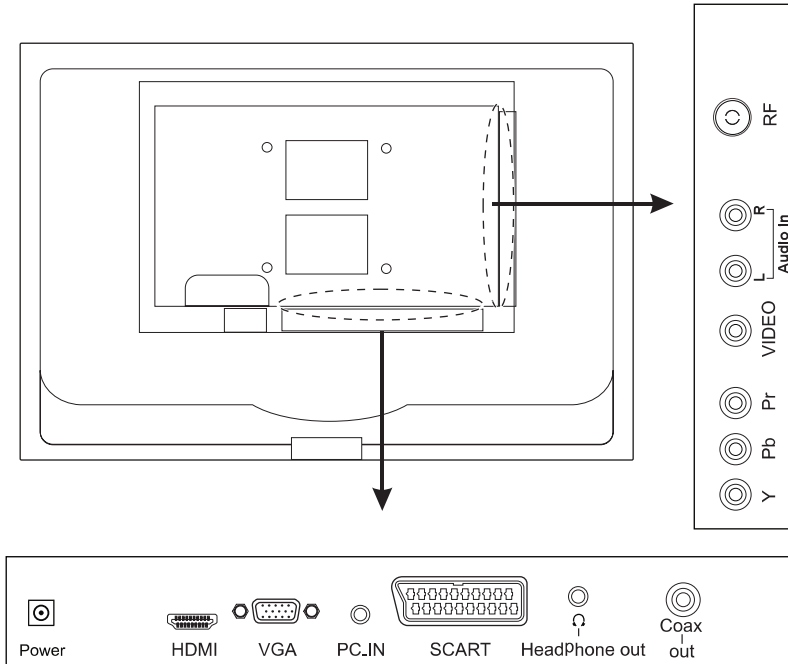

3.2 Connecting random equipment

The appliance includes various options for permanent connection of random equipment. Suitable cables can be purchased at your reseller.

Audio connections (input)

- L/R AUDIO: Connect a suitable cable to the L/R channels of the AUDIO connection.

Video connections

The appliance has the following video outputs (in order of preference):

- HDMI: Connect a suitable cable into the HDMI connection.
- COMPONENT: Connect a suitable cable to the Y/Pb/Pr channels of the COMPONENT connection.
- SCART: Insert a suitable cable into the SCART connection.
- COMPOSITE: Insert a suitable cable into the VIDEO connection.

PC connections

The appliance has the following inputs to connect to your personal computer.

- Audio connection: Connect a suitable cable into the PC IN connection.
- Video connection: Connect a suitable cable into the VGA connection.

Cable connection

- Insert a suitable cable into the RF OUT connection.

Headphone jack

- To connect a headphone, insert the cable plug in the headphone jack. To prevent hearing damage, remember to adjust the volume to a comfortable level.

3.3 Connecting to the mains

- Connect the female connector on the mains cable to the POWER connection.
- Connect the mains plug to a wall socket.

3.4 Remote control

Install batteries

- Remove the battery cover.
- Insert the batteries matching the (+) and (-) polarity markings.
- Re-install the battery cover.



CAUTION

Incorrect installation can cause battery leakage and corrosion which will damage the appliance. Corrosion, oxidation, battery leakage and any other gradually acidic defect of this nature will invalidate the guarantee.

4. Functions

4.1 LED TV/DVD Combi

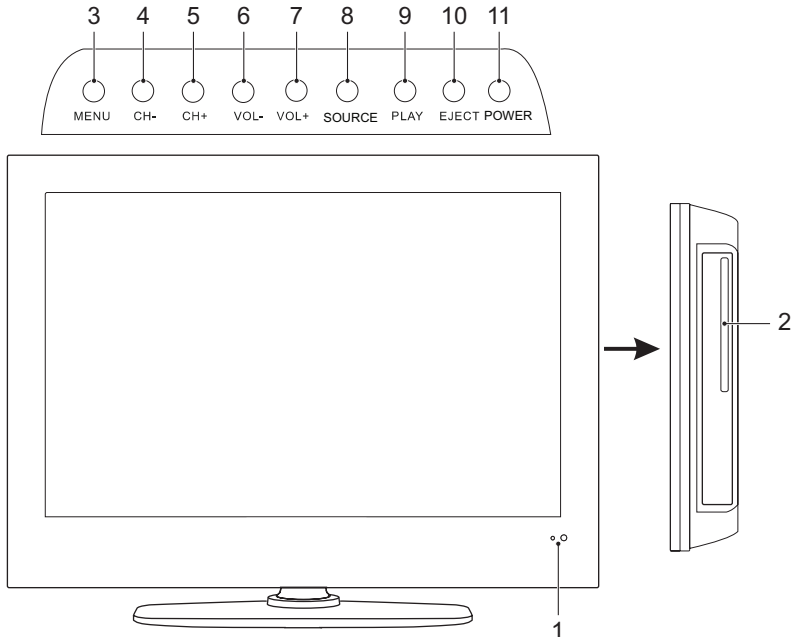

- 1 Remote control sensor / Standby indicator
- 2 DVD slot

Top panel

- | | |
|----------------|-----------------|
| 3 MENU button | 8 SOURCE button |
| 4 CH - button | 9 PLAY button |
| 5 CH + button | 10 EJECT button |
| 6 VOL - button | 11 POWER button |
| 7 VOL + button | |

4.2 Remote control

General functions

- 12 POWER button
- 13 Digit buttons (0-10+)
- 14 VOL + button
- 15 VOL - button
- 16 CH + button
- 17 CH - button
- 18 SYS MENU button
- 19 SOUND button
- 20 PICTURE button
- 21 ASPECT button
- 22 NICAM/A2 button
- 23 TIMER button
- 24 DISPLAY button
- 25 Arrow buttons
- 26 ENTER button
- 27 RETURN button
- 28 MUTE button
- 29 SOURCE button

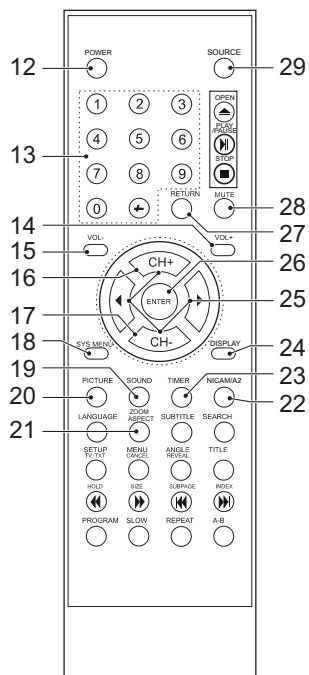

Teletext functions

- 30 CANCEL button
- 31 TV/TXT button
- 32 SIZE button
- 33 HOLD button
- 34 Coloured buttons
- 35 INDEX button
- 36 SUBPAGE button
- 37 REVEAL button

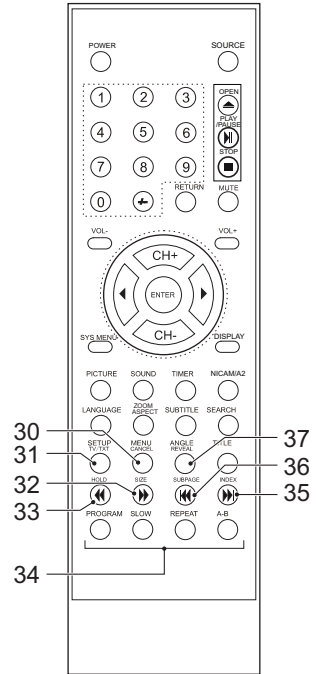

DVD functions

- 38 ZOOM button
- 39 LANGUAGE button
- 40 MENU button
- 41 SETUP button
- 42 FWD button
- 43 REW button
- 44 SLOW button
- 45 PROGRAM button
- 46 A-B button
- 47 REPEAT button
- 48 NEXT button
- 49 PREV button
- 50 TITLE button
- 51 ANGLE button
- 52 SEARCH button
- 53 SUBTITLE button
- 54 DISPLAY button
- 55 STOP button
- 56 PLAY/PAUSE button
- 57 OPEN button

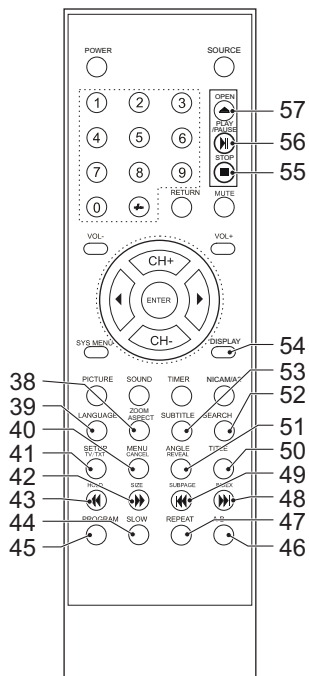

5. Operation

All functions of the appliance are accessible using the remote control. All instructions refer to operation with the remote control, unless indicated otherwise.

5.1 Quick start

General functions

- To switch on the appliance, press the POWER button (12). To switch back to the standby mode, press the POWER button (12) again.
- To select the source mode (TV/AV/Y-Pb-Pr/DVD/SCART/VGA/HDMI), press the SOURCE button (29).
- To adjust the volume, press the VOL + button (14) or the VOL - button (15).
- To mute or restore sound, press the MUTE button (28).
- To set the sleep timer (OFF/15/30/45/60/90/120 min), press the TIMER button (23).
- To select the desired picture mode (USER/NORMAL/SOFT/VIVID), press the PICTURE button (20).
- To select the screen size (16:9, 4:3, ZOOM1, ZOOM2, AUTO), press the ASPECT button (21).
- To select the sound mode (USER/NORMAL/NEWS/MOVIE), press the SOUND button (19).
- To display the setting on the screen, press the DISPLAY button (24).

DVD/CD functions

- Switch on the appliance.
- Select the DVD mode.
- Insert a disc in the slot (2) with the label backwards.
- To start playback, press the PLAY/PAUSE button (56) once.
- For extended instructions, read the paragraph "DVD/CD functions" further on in this manual.

5.2 TV setup menu operation

To change the initial settings

The following actions must be carried out with the remote control:

- Press the SYS MENU button (18).
- Press the arrow buttons (up and down) (25) to select a menu.
- Press the arrow buttons (right) (25) to enter the selected menu.
- Press the arrow buttons (up and down) (25) to adjust the setting.
- Press the SYS MENU button (18) to store the setting and exit.

Picture menu

- PICTURE MODE: to set the picture mode (USER/NORMAL/SOFT/VIVID).
- BRIGHTNESS: to adjust the screen brightness.
- CONTRAST: to adjust the screen contrast.
- SATURATION: to adjust the screen saturation.
- SHARPNESS: to adjust the screen sharpness.
- HUE: to adjust the screen hue (TOWARD PURPLE/TOWARD GREEN).
This option is available for NTSC playback only.
- SCALE: to set the aspect ratio (16:9, 4:3, ZOOM1, ZOOM2, AUTO).



The picture menu can also be entered by pressing the PICTURE button (20).

Sound menu

- SOUND MODE: to set the picture mode (USER/NORMAL/NEWS/MOVIE).
- VOLUME: to adjust the volume.

- BASS: to adjust the bass.
- TREBLE: to adjust the treble.
- BALANCE: to adjust the balance.



The sound menu can also be entered by pressing the SOUND button (19).

Channel menu (TV mode only)

- AUTO TUNE: to tune for channels automatically.
- MANUAL TUNE: to tune for channels manually.
- FINE TUNE: to fine-tune weak channels.
- SKIP: to switch automatic skipping of weak channels ON or OFF.
- SOUND SYS: to select the sound system.
- PROGRAM EDIT: to edit the program.

Function menu

- LANGUAGE: to select the language for the On Screen Display (OSD).
- BLUE BACK: to switch the blue background ON or OFF.
- TTX LANGUAGE: to select the area of the teletext language (WEST/EAST/RUSSIAN/ARABIC/FARSI).
- COLOR TEMP: to set the screen colour temperature (COOL/WARM/NORMAL).
- HOTEL LOCK: to switch the hotel setting menu ON or OFF (password: 0000):



Carefully keep the password to be able to restore the default settings at all times.

- HOTEL MODE: to switch the hotel mode ON or OFF.
- VOLUME CONTROL: to switch the volume control ON or OFF.
- TUNER CONTROL: to switch the tuner control ON or OFF.
- MAX VOLUME: to set the maximum volume.
- CHANGE PASSWORD: to change the password for the hotel mode.
- SOURCE LOCK: to select the source for prohibiting any external input.
- KEYPAD LOCK: to lock or unlock the TV buttons.
- PROG SET: to set the preset source (OFF/TV/AV/Y-Pb-Pr/SCART/VGA/HDMI).
- PROG NUM: to select the program number.
- RESET: to restore the default settings.

PC menu (PC mode only)

- H-POSITION: to adjust the horizontal position of the screen.
- V-POSITION: to adjust the vertical position of the screen.
- CLOCK: to adjust the pixel clock frequency until the image size is maximised for the screen.
- PHASE: to adjust the phase of the ADC sampling clock relative to the sync signal until a stable image is obtained.
- AUTO ADJUST: to adjust the parameters of the screen automatically.

5.3 TV functions

Teletext functions

- Press the TV/TXT button (31) to open the Teletext mode.
- To select a page, press in the number using the digit buttons.
- To select the next or previous page, press the CH + button (16) or the CH - button (17).
- To select the index page, press the INDEX button (35).
- To show hidden information, press the REVEAL button (37) (optional for some Teletext pages).
- To select the size of Teletext page:
 - Press the SIZE button (32) once to enlarge the upper half of the page.
 - Press the button once again to enlarge the lower half of the page.
 - Press the button once again to cancel the function.
- To hold a Teletext page, press the HOLD button (33).
- Press a coloured button (34) to select a quick link to a teletext page.

5.4 DVD/CD functions

After the disc has been loaded, a content menu will display on the TV screen.

- Press the arrow buttons (25) to select a menu item.
- Press the ENTER button (26) to enter the selected menu item.

During playback, the following functions are available:

- To select a chapter (DVD) or track (CD), press the digit buttons (13).
- To select the next or previous chapter (DVD) or track (CD), press the NEXT button (48) or the PREV button (49).
- To forward or rewind the DVD, press the FWD button (42) or the REW button (43). The available speeds are: 2x, 4x, 8x, 20x.

- To pause playback, press the PLAY/PAUSE button (56) once. To resume playback, press the PLAY/PAUSE button (56) again.
- To stop playback temporarily, press the STOP button (55) once. To stop playback permanently, press the STOP button (55) again or press the PLAY/PAUSE button (56).
- To playback in slow-motion, either forward or backward, press the SLOW button (44) repeatedly. The available speeds are: 1/2, 1/3, 1/4, 1/5, 1/6, 1/7.
- To repeat a chapter (DVD) or one or all tracks (CD):
 - Press the REPEAT button (47) once to repeat the current chapter or track.
 - Press the button once again to repeat the current title.
 - Press the button once again to repeat all chapters or tracks.
 - Press the button once again to cancel the function.
- To view a specific title of a DVD, press the TITLE button (50). Use the arrow buttons to select the title.
- To select the audio language of a DVD, press the LANGUAGE button (39) repeatedly until the desired language is set.
- To switch on the subtitles of a DVD, press the SUBTITLE button (53). Press the button again to switch off the subtitles.
- To select extra information of a DVD or CD (remaining time/passed playtime/track number/chapter number), press the DISPLAY button (54).
- To select the camera angle, press the ANGLE button (51).
- To return to the main menu, press the MENU button (40).



- A DVD that does not match the region code cannot be read by this appliance.

Using the PROGRAM function

- Press the PROGRAM button (45) to enter the PROGRAM function.
- To play tracks from a CD:
 - Press the arrow button (right) (25) to highlight the title.
 - Press the arrow buttons (up and down) (25) to select the title.
- To play chapters from a DVD:
 - Press the arrow button (right) (25) to highlight the title.
 - Press the arrow buttons (up and down) (25) to select the title.
 - Press the arrow button (right) (25) to highlight the chapter.
 - Press the arrow buttons (up and down) (25) to select the chapter.

- To confirm the selection, press the ENTER button (26).
- Repeat the last 2 steps to add additional titles or chapters.
- Press the PLAY/PAUSE button (56) to start the program.

Using the A-B REPEAT function

The A-B REPEAT function can be used to repeat a specific section of a DVD.

- Press the A-B button (46) once to select the starting point (A).
- Press the A-B button (46) again to select the ending point (B).
The appliance plays the section repeatedly.
- Press the A-B button (46) again to cancel the function. The appliance will resume the normal playback.

Using the SEARCH function

The SEARCH function can be used to select a specific starting point on a DVD or CD.

- Press the SEARCH button (52)(25).
- Press the arrow buttons to select an entry.

The possible entries for DVD are:

- Disc time
- Chapter
- Title
- Chapter time
- Title time

The possible entries for CD are:

- Track time
- Specific track
- Press the digit buttons to set a selection.

Using the MP3/MPEG4 playback function

- Insert an MP3/MPEG4 disc. A content menu will display on the TV screen.
- Press the up/down arrow buttons (16/17) to select a folder or a file.
- Press the ENTER button (26) to enter the selected folder or file.
- Press the MENU button (40) to switch between folders and files. Press the ENTER button (26) to confirm.

5.5 DVD setup menu operation



This menu only works in DVD mode.

To change the initial settings

The following actions must be carried out with the remote control:

- Press the SETUP button (41) to select the setup menu.
- Press the arrow buttons to select an item and change the settings.
- Press the SETUP button (41) to store the settings and exit.

System setup page



This menu only works with an empty DVD player.

TV SYSTEM

- To select the colour system (NTSC/PAL/AUTO).

TV TYPE

- To select the aspect ratio (4:3PS/4:3LB/16:9).

PASSWORD

- To set the password.

RATING

- To set the parental rating password.

DEFAULT

- To restore the default settings of the appliance.

Language setup page

- In the OSD LANGUAGE section, press the arrow buttons to choose the language.
- In the AUDIO section, choose the audio language.
- In the SUBTITLE section, choose the subtitle language.
- In the DVD MENU section, choose the language for the DVD menu.

Audio setup page

AUDIO OUT

- Select SPDIF OFF to switch off the digital audio signal output.
- Select SPDIF RAW to set the digital audio signal output to its raw format (DTS/Dolby Digital 5.1).
- Select SPDIF PCM to set the digital audio signal output to PCM format.

Digital setup page

DYNAMIC

- Select the value for the dynamic range compression to avoid losing sound details resulting from a low volume.

DUAL MONO

- Stereo: both channels as is. STEREO is the default setting.
- L-Mono: left channel only.
- R-Mono: right channel only.
- Mix-Mono: the average of both the left and right channel.



This function is only available for Dolby AC-3 encoded 2-channel discs.

6. Cleaning and maintenance



WARNING

Before performing any cleaning or maintenance, switch off and unplug the appliance.

- Clean the outside of the appliance with a soft cloth. When the appliance is very dirty, dampen the cloth slightly with water and a neutral solution.

6.1 Handle and care of a disc

- Hold the disc with fingers. Hold the disc outer edge and/or the centre spindle hole. Do not touch the disc surface.
- Do not bend or press the disc. Do not expose the disc to direct sunlight or heating sources.
- Clean the disc surface with a soft, dry cleaning cloth. Wipe the disc surface gently, radially, from centre towards the outer edge.

- Do not apply thinner, alcohol, chemical solvent, or sprays when cleaning. Such cleaning fluids will permanently damage the disc surface.

7. Troubleshooting

Trouble	Action
No sound or incomplete audio	<p>Check if the random equipment are switched on and set correctly.</p> <p>Check cables for connection problems.</p> <p>Check if the correct source is selected.</p> <p>Check volume or mute setting.</p>
No picture	<p>Check if the TV is switched on and set to the correct A/V input.</p> <p>Check cables for connection problems.</p>
No power	<p>Check if the power cord has been properly connected to the power outlet.</p>
Malfunction	<p>Should the appliance develop a serious malfunction, unplug the appliance for 30 minutes. After this, power on the appliance and restore to factory default.</p>

DVD/CD

Trouble	Action
No playback	<p>There is no disc inserted. Load a disc in the appliance.</p> <p>Disc is loaded label facing backward. Place the disc with the label facing forward.</p> <p>Rating level of the disc is higher than the rating level setting of the appliance.</p> <p>Invalid region code.</p> <p>Incorrect type of disc.</p> <p>Disc may be damaged or dirty, clean the disc or try another disc.</p> <p>Moisture may have condensed inside the appliance. Remove the disc and leave the appliance powered on for one or two hours.</p>

No sound or incomplete audio	Select another audio track. During SCAN, SLOW MOTION or SINGLE STEP the sound is muted. Check if the disc is in fast forward or fast rewind mode. Press the PLAY/PAUSE button (56).
No scan or skip possible	Some discs are programmed to refuse user action at certain sections. This is no malfunction. Single chapter or track discs do not allow skip function.
Picture distorted or noisy	Disc may be damaged or dirty, clean the disc or try another disc. Check TV system setting (PAL/NTSC). A VCR is connected between the appliance and the random equipment. Connect the appliance to a A/V directly. Clean the disc.
Picture not full screen	Select the screen format from the appliances setup menu. Select screen format in disc start menu.

Remote control (RC)

Trouble	Action
RC does not function	Check the battery installation. Point the RC at the remote control sensor. Stay within 8 metres of the appliance.

8. Technical data

Parameter	Value
Voltage	100 ~ 240 V _{AC} / 50 ~ 60 Hz
Power consumption	60 W
Standby power consumption	<1 W
Max power output	2 x 3 W (2 x 1 W RMS)
Headphones output impedance	32 Ω
Dimensions (W x H x D)	
without foot	595 x 435 x 50 mm
with foot	595 x 450 x 170 mm
Weight	5.4 kg

LED screen

Parameter	Value
Diagonal size	60 cm (24")
Ratio	16:9
Resolution	1920 x 1080 pixels
Brightness	250 cd/m ²
Contrast ratio	1000:1
Response time	5 ms
Viewing angle horizontally / vertically	170°/170°
Television system	PAL/SECAM

Set-up

Parameter	Value
Wall mountable	VESA standard (100 x 100 mm)

Remote control

Parameter	Value
Power consumption	2 x 1.5 V
Battery size	AA

9. Disposal of used electrical and electronic equipment



The meaning of the symbol on the material, its accessory or packaging indicates that this product shall not be treated as household waste. Please, dispose of this equipment at your applicable collection point for the recycling of electrical and electronic equipments waste. In the European Union and Other European countries which there are separate collection systems for used electrical and electronic product. By ensuring the correct disposal of this product, you will help prevent potentially hazardous to the environment and to human health, which could otherwise be caused by unsuitable waste handling of this product. The recycling of materials will help conserve natural resources. Please do not therefore dispose of your old electrical and electronic equipment with your household waste.

For more detailed information about recycling of this product, please contact your local city office, your household waste disposal service or the shop where you purchased the product.

For more information and warranty conditions, please visit: www.akai.eu



Heeft u na het lezen van deze handleiding nog vragen?
Neemt u dan contact op met AKAI Benelux via:

0900-3555333

Avez-vous des questions après avoir lu ce manuel?
Contactez AKAI Benelux par téléphone au :

070-355505

www.akai.eu